



---

***GS-2406T / GS-3405T Series***

**THERMAL TRANSFER / DIRECT THERMAL  
LABEL PRINTER**

**USER'S  
MANUAL**



Ver:1.1.6

# Agency Compliance and Approvals

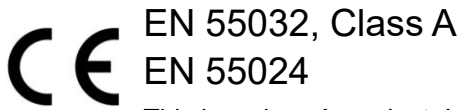

This is a class A product. In a domestic environment this product may cause radio interference in which case the user may be required to take adequate measures.

## FCC part 15B, Class A



This equipment has been tested and found to comply with the limits for a Class A digital device, pursuant to Part 15 of the FCC Rules. These limits are designed to provide reasonable protection against harmful interference when the equipment is operated in a commercial environment. This equipment generates, uses, and can radiate radio frequency energy and, if not installed and used in accordance with the manufacturer's instruction manual, may cause harmful interference with radio communications. Operation of this equipment in a residential area is likely to cause harmful interference, in which case you will be required to correct the interference at your own expense.

## WARNING

This is a Class A product. In a domestic environment this product may cause radio interference in which case the user may be required to take adequate measures.

## Environmental protection



Do not dispose of this product in an unsorted public trash can. You should recycle this product according to local regulations.

For more information, please browse our website : <http://www.gainscha.com.tw>

# Contents

---

1. Introduction .....	4
1.1 Product Introduction .....	4
1.2 Product Features .....	6
1.2.1 Printer Standard Features .....	6
1.2.2 Printer Optional Features .....	8
2. Operations Overview .....	9
2.1 Unpacking and Inspection .....	9
2.2 Printer Overview .....	10
2.2.1 Front View .....	10
2.2.2 Interior View .....	10
2.2.3 Front View .....	11
2.2.4 Rear View .....	11
3. Setup .....	12
3.1 Setting up the Printer .....	12

3.2 Install Printer Driver .....	13
3.3 Loading the Ribbon .....	16
3.4 Loading the Media .....	17
3.4.1 Loading the Roll Labels .....	17
3.4.2 Ribbon and print media loading diagram .....	17
3.4.3 External Label Roll Mount Installation (Option) .....	18
3.5 Loading the Cutter .....	19
3.6 Loading the Peeler .....	22
4. LED and Button Functions .....	25
4.1 LED Indicator .....	25
4.3 Power-on Utilities .....	27
5. PirnterUtility .....	28
5.1 Start the PirnterUtility .....	28
5.2 Printer Function .....	29
6. Communication Interfaces.....	30
7. Troubleshooting.....	32

7.1 Common Problems.....	32
8. Maintenance.....	34
9. Revise History.....	35

# 1. Introduction

---

## 1.1 Product Introduction

Thank you very much for purchasing Gainscha bar code label printer.

The GS-2406T/GS-3405T series printer features the single motor that is capable of handling a large capacity of 300 meters ribbon and large rolls of media inside its sleek design. If the 5" interior label capacity is not enough, simply add an external media roll mount and the GS series can easily handle 8" OD rolls of labels designed for expensive industrial label printers.

To meet the various printing requirements, GS-2406T and GS-3405T series provides different memory capacity. Moreover, GS-2406T/ GS-3405T series have optional peel-off and cutter kits for users to purchase. The movable black mark sensor design can accept a wide range of label media. All of the most frequently used bar code formats are included. Fonts and bar codes can be printed in any one of the four directions.

The GS-2406T/ GS-3405T series printer is built-in the flexible firmware design, user can download various printer commands to perform the work. Please refer to the types of printer commands supported in the specifications. By integrating rich features, it is the most cost-effective and high-performance printer in its class!

To print label formats, please refer to the instructions provided with your labeling software, available on Gainscha website <http://www.gainscha.com.tw>

- Applications
  - Manufacturing & Warehousing
    - Work in Progress
    - Item Labels
    - Instruction labels
    - Agency labels
  - Healthcare
    - Patient Identification
    - Pharmacy
    - Specimen Identification
  - Parcel Post
    - Shipping/ Receiving Labels
  - Small Office/ Home Office
  - Retail Marking
    - Price tags
    - Shelf labels
    - Jewelry tags

## 1.2 Product Features

### 1.2.1 Printer Standard Features

PRINTER MODEL	GS-2406T	GS-3405T	GS-2406T	GS-3405T
Level	Economic	Economic	Empower	Empower
Resolution	8dots/mm (203DPI)	12dots/mm (300DPI)	8dots/mm (203DPI)	12dots/mm (300DPI)
Printing Method	Thermal Transfer & Direct Thermal			
Max. print speed	152mm(6") /second	127mm(5") /second	152mm(6") /second	127mm(5") /second
Max. print width	104 mm (4.1")	108.4 mm (4.27")	104 mm (4.1")	108.4 mm (4.27")
Max. print length	2,794 mm (110")	1,016 mm (40")	25,400 mm (1000")	11,430 mm (450")
CPU specifications	400 MHZ, 32 bits, ARM9			
Memory RAM	64 MB SDRAM		64 MB SDRAM	
Memory ROM	32 MB Flash Memory		128 MB Flash Memory	
Interface	<ul style="list-style-type: none"> <li>➤ USB 2.0 High Speed 480Mbps</li> <li>➤ USB Host 2.0, for scanner or PC keyboard</li> </ul>		<ul style="list-style-type: none"> <li>➤ USB 2.0 High Speed 480Mbps</li> <li>➤ USB Host 2.0, for scanner or PC keyboard</li> <li>➤ RS-232</li> <li>➤ Internal Ethernet 10/100Mbps</li> </ul>	
Real Time Clock	N/A		Standard (CR2032 Battery Install)	



<b>Buzzer</b>	N/A	Standard
<b>Dealer options</b>	N/A	<ul style="list-style-type: none"> <li>➤ Guillotine cutter (full cut and partial cut)</li> <li>➤ Peeler</li> </ul>
<b>Sensors</b>	Head open sensor, Ribbon end sensor, Reflective sensor (moveable), Transmissive sensor (moveable)	
<b>Power</b>	External universal switching power supply Input: AC 100-240V, 2.5A, 50-60Hz, Output: DC 24V, 2.5A, 60W	
<b>User Interface</b>	1 power switch, 2 buttons(Feed & Pause), 3 LEDs (Online, Error, Ribbon status)	
<b>Internal fonts</b>	<ul style="list-style-type: none"> <li>➤ 8 alpha-numeric bitmap fonts</li> <li>➤ True type font engine (need download scalable font file)</li> </ul>	
<b>1D Barcode</b>	Code 11, Code 39, Code 93, Code 128 (subsets A, B, C), UPC-A, UPC-E, UCC-128, Codabar, EAN/JAN-8, EAN/JAN-13, Interleaved 2 of 5, ITF14, MSI Pleassy, PostCode, Telepen	
<b>2D Barcode</b>	QR Code, Micro QR Code, PDF417, Micro PDF417, MaxiCode, Aztec Code, Data Matrix	
<b>Rotation</b>	Font and barcode support 0, 90, 180, 270 degree rotation	
<b>Printer language</b>	Compatible to TSPL, EPL, ZPL, ZPL II	
<b>Ribbon</b>	300 M long, max. OD 67 mm, 1" core (ink coated outside)	
<b>Ribbon width</b>	30 mm ~ 110 mm (1.18" ~ 4.3")	
<b>Media type</b>	Continuous, die-cut, black mark, fan-fold, notched (outside wound)	
<b>Media width</b>	20~ 118 mm (0.7" ~ 4.6")	
<b>Media thickness</b>	0.055 ~ 0.19 mm (2.16 ~ 7.4 mil)	
<b>Media core diameter</b>	25.4 mm (1")	

<b>Label roll capacity</b>	127 mm (5") OD			
<b>Label length</b>	5 ~ 2,794 mm (0.2" ~ 110")	5 ~ 1,016 mm (0.2" ~ 40")	5 ~ 25,400 mm (0.2" ~ 1000")	5 ~ 11,430 mm (0.2" ~ 450")
<b>Physical dimension</b>	280mm(D) x 200mm(W) x 182mm(H)			
<b>Enclosure</b>	ABS plastic			
<b>Safety certification</b>	FCC Class A, CE Class A, CCC, BIS, CB			
<b>Environment condition</b>	Operation: 5 ~ 40°C, 25 ~ 85% non-condensing Storage: -40 ~ 60°C, 10 ~ 90% non-condensing			
<b>Environmental concern</b>	Comply with RoHS, REACH, WEEE			

### 1.2.2 Printer Optional Features

<b>Product option feature</b>	<b>User options</b>	<b>Dealer options</b>	<b>Factory options</b>
<b>External Label holder</b>	<input type="radio"/>		
<b>Peeler module</b>		<input type="radio"/>	
<b>Regular full cut cutter (Guillotine cutter)</b> Media thickness: 0.06~0.19 mm Media type: receipt and label liner w/o glue		<input type="radio"/>	
<b>Regular full/partial cutter (TextileCare Cutter)</b>		<input type="radio"/>	
<b>RS-232 (D-Sub9 pins)</b>		<input type="radio"/>	<input type="radio"/>
<b>Ethernet 10/100 Mbps (RJ-45)</b>		<input type="radio"/>	<input type="radio"/>

NOTE :Except for the linerless cutter, all regular/heavy duty/care label cutters DO NOT cut on media with glue.

## 2. Operations Overview

---

### 2.1 Unpacking and Inspection

This printer has been specially packaged to withstand damage during shipping. Please carefully inspect the packaging and printer upon receiving the bar code printer. Please retain the packaging materials in case you need to reship the printer.

Unpacking the printer, the following items are included in the carton.

- One printer unit
- One quick installation guide
- One power cord
- One external universal switching power supply
- One USB interface cable
- 1inch core ribbon shaft for 300m ribbon
- One sample ribbon and Label roll
- One Windows labeling software/Windows driver CD disk

If any parts are missing, please contact the Customer Service Department of your purchased reseller or distributor.



## 2.2 Printer Overview

### 2.2.1 Front View



1. ONLINE indicator
2. ERROR indicator
3. RIBBON indicator
4. PAUSE button
5. FEED button

### 2.2.2 Interior View



1. Printer top cover
2. Top cover open tab
3. The place for new ribbon
4. Fixing tabs
5. Media guide
6. Gap sensor
7. Black mark sensor
8. Platen roller
9. Power switch

### 2.2.3 Front View

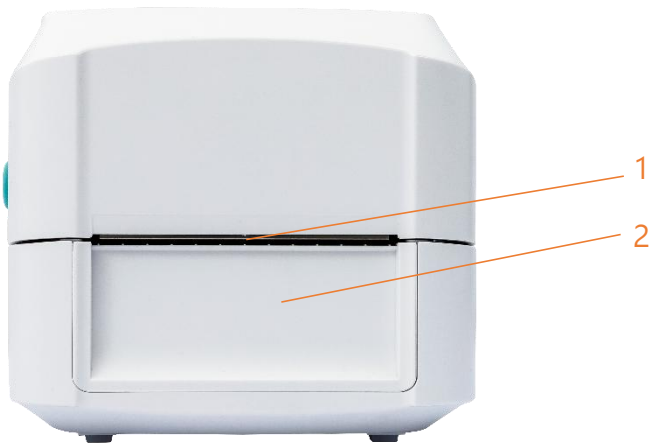

- 1. Paper tearing edge
- 2. Front bezel;  
Accessory assembly ( Cutter / Peeler)

### 2.2.4 Rear View

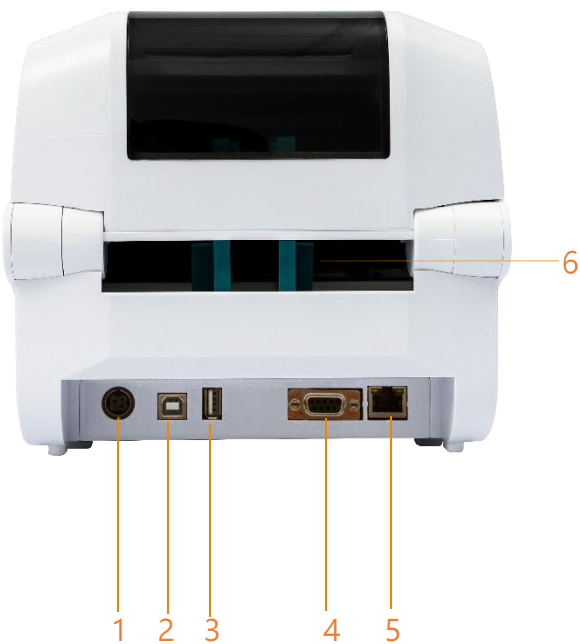

- 1. Power socket
- 2. USB interface
- 3. USB host (For HID keyboard or scanner)
- 4. RS-232 interface (Optional)
- 5. RJ-45 Ethernet interface (Optional)
- 6. External label entrance chute

## 3. Setup

---

### 3.1 Setting up the Printer

Place the printer on a flat, secure surface, then follow the steps below:

1. Plug the power cord into the AC power cord socket at the rear of the printer. Then, plug the other side into a properly grounded power outlet.
2. Connect the printer to the computer with the provided USB cable.
3. Push the power switch on “-” side to open the power of printer.

**NOTE:**

- \* Please switch OFF printer power prior to plugging in the power cord to printer power jack.
- \* The interface picture here is for reference only. Please refer to the product specification for the interfaces availability.

## 3.2 Install Printer Driver

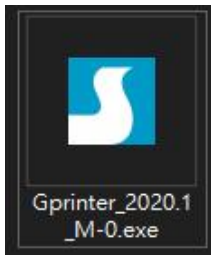

1. Read the license agreement, click [I accept the terms in license agreement], and click [Next].

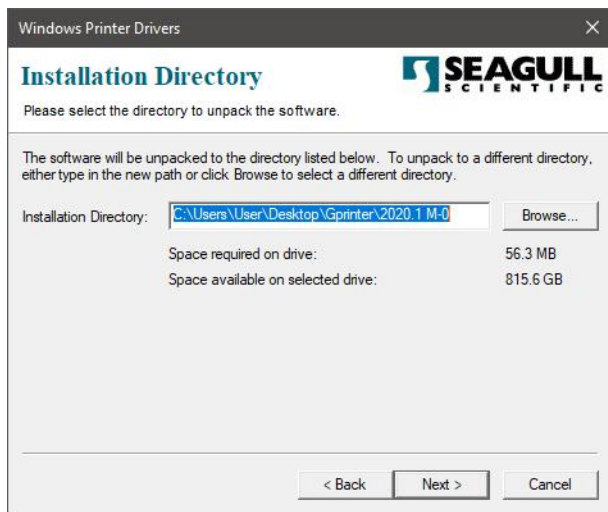

2. Select a installation directory and click [Next].

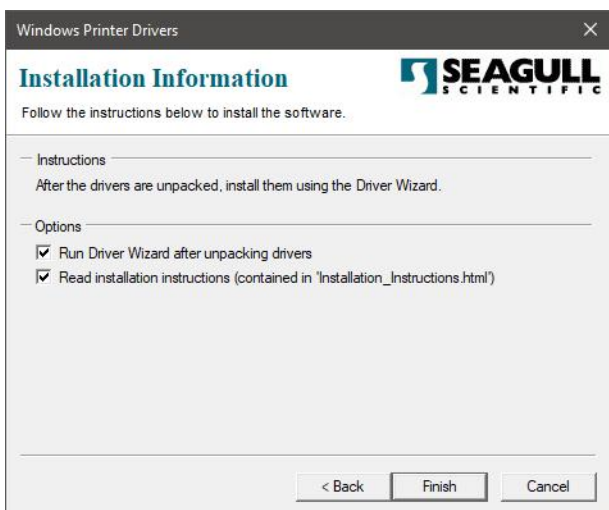

3. Click [Finish].



4. Go to installation process, please click [Install Printer Driver], and then click [Next].

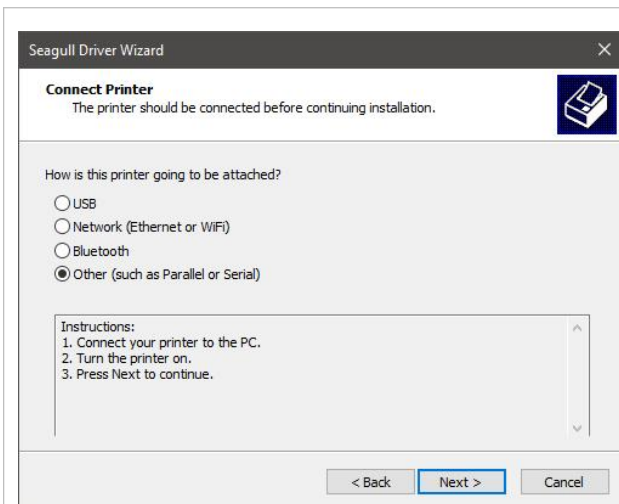

5. Click [Other] and click [Next].

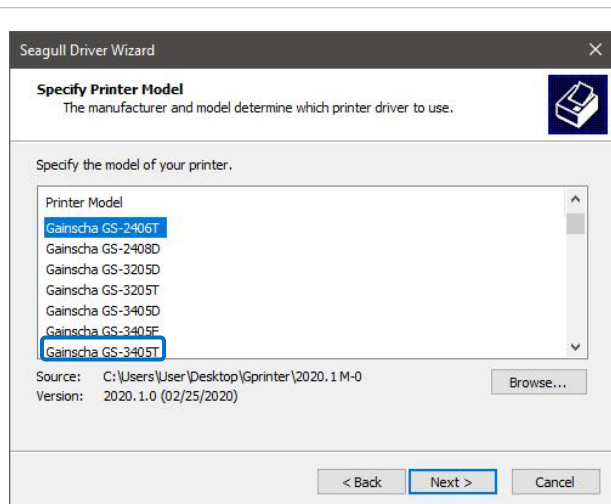

6. Select printer model name, click to install and click [Next].

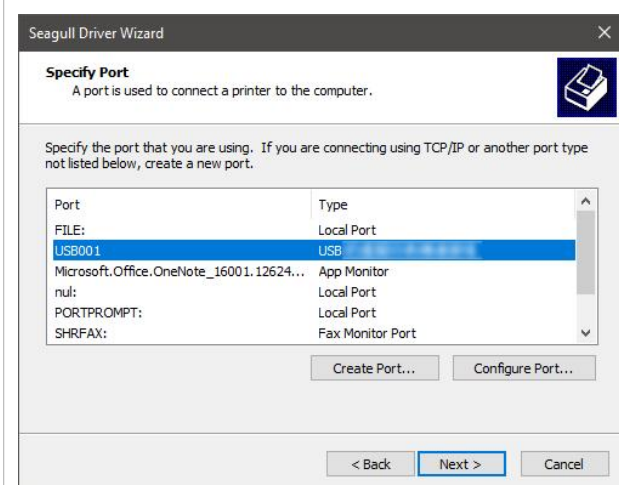

7. Please use a USB cable to connect the printer to the computer, click the corresponding USB interface, and click [Next].

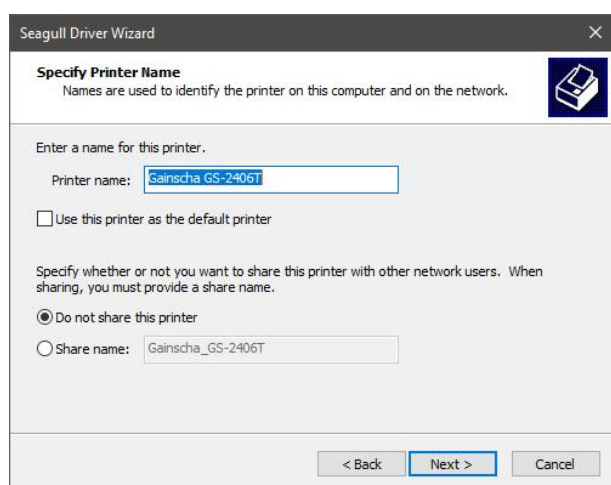

8. Change the printer name as per need, and click [Next].

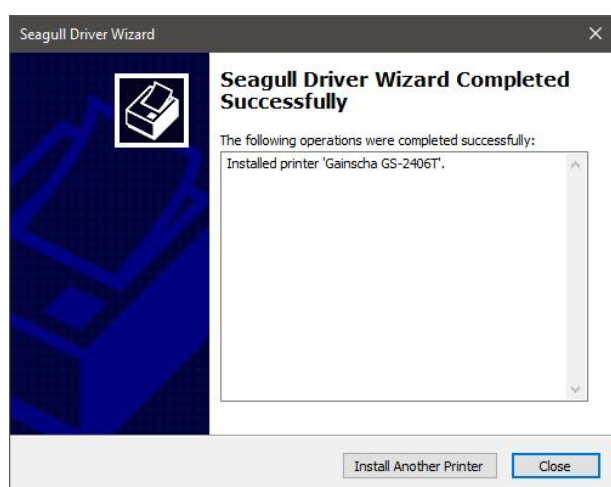
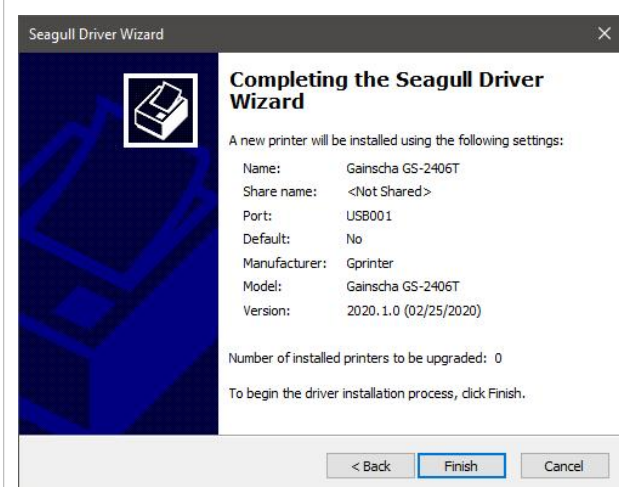



9. Click [Finish].

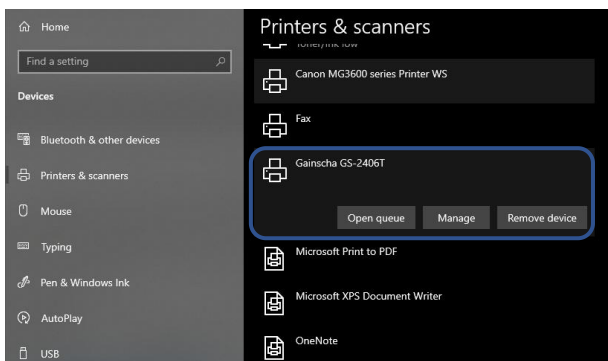

10. The installation is completed, please click [Close].

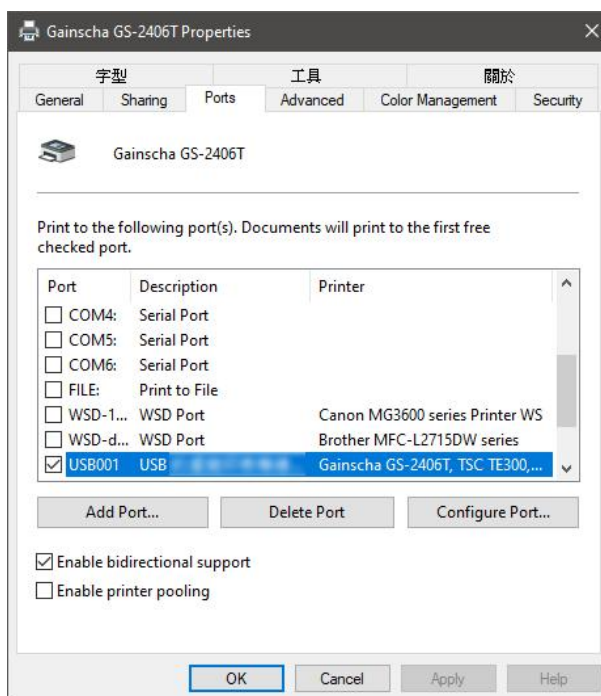

11. Users can check whether the installation is completed through the following ways:

- a. If Windows 10, check from [Windows Settings] → [Devices] → [Printers and Scanners].
- b. Check from [Control Panel] → [Devices and Printers].

12. Users can change printer interface through the following ways:

- a. In Windows 10, [Windows Settings] → [Printers and Scanners] → [Devices] → select the corresponding printer model → [Management] → [Printer Content] → [Port] to change different USB port / COM port as per need.
- b. From [Control Panel] → [Devices and Printers] → select the corresponding printer model → right-click → [Printer Content] → [Port] to modify it.

### 3.3 Loading the Ribbon

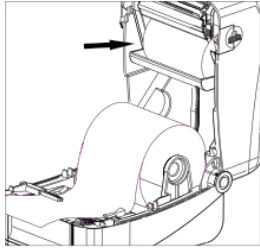
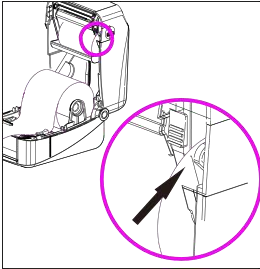
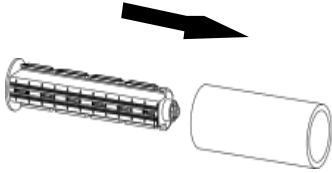
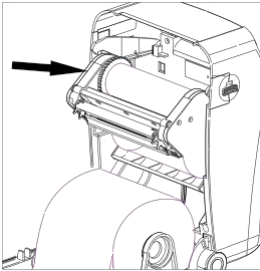
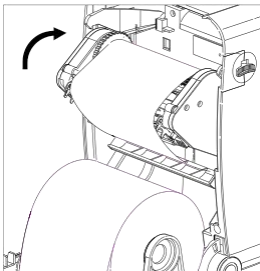
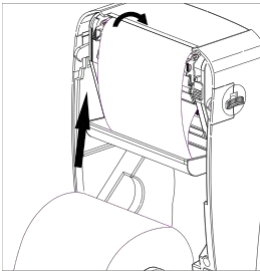
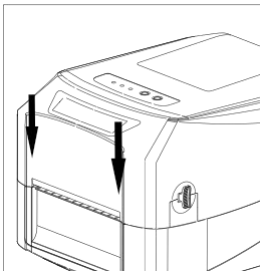
	
<p>1. Insert black ribbon roller into new ribbon.</p>	<p>2. Load ribbon left side first and then right side, fix it well.</p>
	
<p>3. Press the button to open ribbon holder unit as per picture</p>	<p>4. Insert blue ribbon roller into the empty roll for ribbon collecting after printed</p>
	
<p>5. Load the empty roll left side first, then right side.</p>	<p>6. Pull out ribbon and stick into the empty roll. Make sure ribbon is flat and smooth when touch print head.</p>
	
<p>7. Put ribbon holder back to its position as picture showing.</p>	<p>8. Carefully close top cover.</p>

## 3.4 Loading the Media

### 3.4.1 Loading the Roll Labels

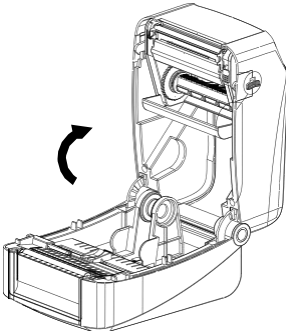
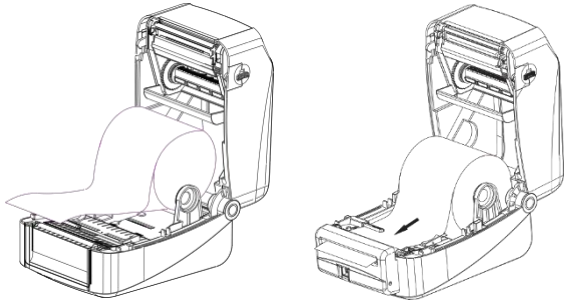
	
<p>1. Press two buttons on printer two sides to lift and open the cover.</p>	<p>2. Load print media into the printer; adjust the paper guide to be same width of print media.</p>

### 3.4.2 Ribbon and print media loading diagram

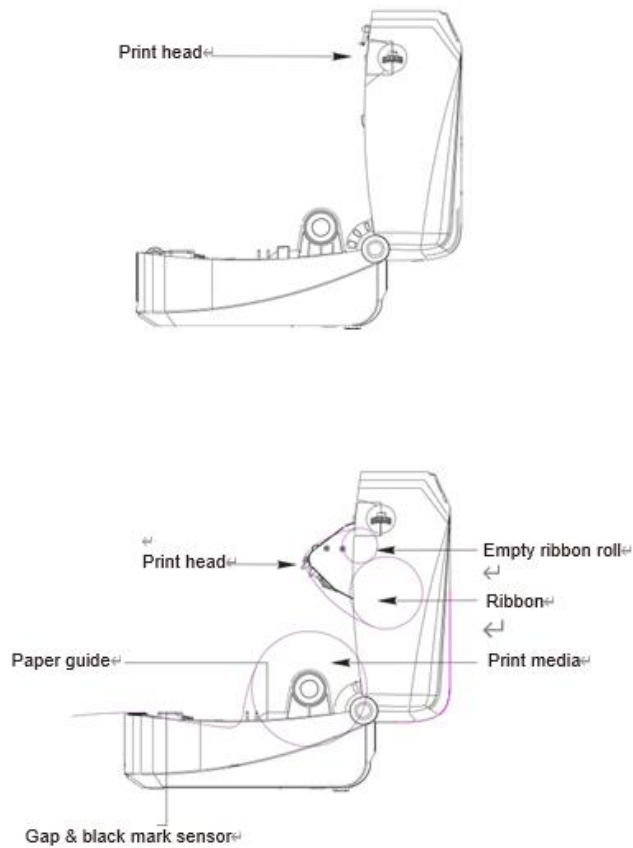

### 3.4.3 External Label Roll Mount Installation (Option)

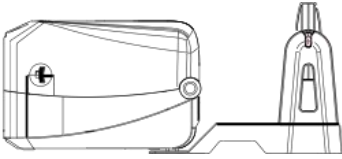
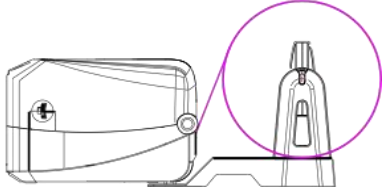
	
<p>1. Attach the external stent on the bottom of the printer.</p>	<p>2. Insert a label spindle into a paper roll. Then, install it on the external paper roll mount.</p>

Note : When using the Gainscha External Label holder, the 1" core label spindle only supports a radius of 12 cm / 2" core label spindle only supports a radius of 10 cm / 3" core label spindle only supports a radius of 8.5 cm

### 3.5 Loading the Cutter

 <p>1.</p> <p>2.</p>	<p>Depending on the purchase, there will be two different cutters.</p> <ol style="list-style-type: none"><li>1. TextileCare Cutter</li><li>2. Guillotine cutter</li></ol>
	<ol style="list-style-type: none"><li>1. Push the cover button backwards with both hands to open the printer cover</li></ol>
	<ol style="list-style-type: none"><li>2. Align the cutter with the tenon, and place the wire of the cutter into the hole</li><li>3. When attaching the cutter, take care not to press it on the wire, and lock the cutter with the screw</li></ol>



4. Turn the printer upside down, remove the four screws located on the bottom cover, and open the bottom cover



5. After opening, insert this cutter board and lock the cutter board with two screws



6. Make sure the wafer 1X10P P2.0 connector is plugged into the cutter board
7. Pull out the wire just put into the hole and insert it into the wafer 1x7P P1.25 connector on the cutter board
8. After inserting it, cover the bottom cover and lock the screws



9. Open the small cover, insert the wafer 1X10P P2.0 connector of the cutter board into the main board, then lock the screws.



10. Finish

### 3.6 Loading the Peeler

	<p>Peeler</p>
	<ol style="list-style-type: none"><li>1. Push the cover button backwards with both hands to open the printer cover</li></ol>
	<ol style="list-style-type: none"><li>2. Align the peeler with the tenon and place the wire of the peeler into the hole</li><li>3. When closing the peeler, be careful not to press it on the wire, and lock the peeler with screws</li></ol>





4. Turn the printer upside down, remove the two screws located on the bottom cover, and open the bottom cover



5. After opening, pull out the wire just put into the hole and insert it into the wafer 1x7P P1.25 connector on the main board

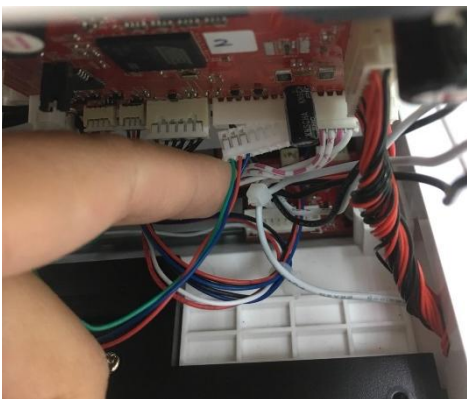

6. After inserting it, cover the bottom cover and lock the screws



## 7. Finish

Note: Please clamp the label roll with the fixing tabs and clamp the media with the media guide, so as not to cause the media to roll into the peeler and cause the phenomenon that the media cannot be peeled off.

# 4. LED and Button Functions

## 4.1 LED Indicator

Event	Description	Status lights 1	Status lights 2	Beep
Thermal transfer mode ready	Blue(ONLINE) and Green(RIBBON) solid, and the device is ready to use.			
Direct thermal mode ready	Blue(ONLINE) solid, and the device is ready to use.			
Open cover	When the cover is open, a beep sound will be made, and Blue(ONLINE), Red (ERROR), and Green(RIBBON) will flash.			
PAUSE	Press the PAUSE button. When the Blue(ONLINE) flash, the printer will pause.			
FEED	Press the FEED button to print as per demand, Blue(ONLINE) will flash.			
Out of paper	When out of paper, a beep sound will be made, and Red(ERROR) flash			
Out of ribbon	When out of ribbon, a beep sound will be made, and Red(ERROR) solid · Green(RIBBON) flash			
Label gap/black mark error	When label gap/black can't be found, a beep sound will be made, and Red(ERROR) Blue(ONLINE) flash			
Cutter error	When cutter can't be found, a beep sound will be made, and Blue(ONLINE) · Red(ERROR) Both flash alternately, flash with Green(RIBBON)			
Print head overheated	When print head overheated ,a beep sound will be made, and Blue(ONLINE)and Red(ERROP) alternately flash			
Other errors	When other errors ,a beep sound will be made, and Red(ERROP) and Green(RIBBON) alternately flash			



## 4.2 Regular Button Functions











This printer has two buttons for feed, pause or cancel errors. There are different functions in different modes, as shown in the following table:

<b>Button</b>	<b>Printer status</b>	<b>Function</b>	<b>Description</b>
<b>Feed button</b>	Ready	Feed	When the printer is ready (Blue LED ON), press this button once, and the label will advance to the front of the next label
<b>Feed button</b>	Wait for push button to print	Print next	When the button Demand function is activated, the printer will stop after printing and wait for the user to press this button before printing the next label.
<b>Pause button</b>	Print mode	Pause	When the printer is printing continuously, pressing the PAUSE button will pause printing. The power indicator is blue flashing. Just press the button again, and the print job returns to normal.
<b>Pause button</b>	Error occurred	Cancel error	When the error RED is on, press the PAUSE button once, the printer will cancel the error and resume printing function, and reprint the label layout when the error occurs.

## 4.3 Power-on Utilities

This printer has six power-on functions for setting or testing the printer's hardware. Press these buttons at the same time when the power is turned on, and release the buttons with the light signal to activate these functions.

Follow these steps to enable the boot function:

Event	Description	Status lights	Beep
<b>Self-test</b>	A. Power off the printer. B. Make sure the printer is loaded with paper and the cover is closed. C. Press the FEED button, and turn on the printer. Hold the button until the online Blue is on. After a beep, a self-test page will be printed.		
<b>Enter USB storage device function</b>	A. Power off the printer. B. Make sure the printer is loaded with paper and the cover is closed. C. Press the PAUSE button, and turn on the printer. Hold the button until the online Blue is on. After a beep, the printer's storage device will appear on the computer.		
<b>Enter dump mode</b>	A. Power off the printer B. Make sure the printer is loaded with paper and close the printer cover C. Press and hold the PAUSE and FEED buttons at the same time for two seconds, then turn on the printer's power. When the online Blue and the error Red are on at the same time, release PAUSE and FEED buttons, when you hear a beep, the printer enters the dump mode and will print out "NOW IN DUMP MODE".		
<b>Skip AUTO.BAS</b>	A. Power off the printer B. Press and hold PAUSE and FEED buttons for four seconds at the same time, and turn on the printer power until the power Blue is off, and the error Red is on, release PAUSE and FEED buttons, two beeps are heard. At this time, the printer will skip the AUTO.BAS program, and then the power light is on.		
<b>Printer initialization</b>	A. Power off the printer B. Press and hold PAUSE and FEED buttons at the same time for six seconds, and turn on the printer power until the printer online Blue is on and error Red is off, release PAUSE and FEED buttons, five beeps are heard. At this time the printer will restore the printer parameters to the factory default settings.		
<b>Ribbon inspection</b>	The machine will automatically detect the status of the ribbon after turning on and in each thermal transfer printing mode.		

# 5. PirnterUtility

Printer Utility is an integrated tool software that helps users query printer settings and status, change printer-related settings, and send commands or files to the printer.

## 5.1 Start the PirnterUtility

1. Please mouse over Printer Utility icon  Printer Utility.exe image Double click left mouse button.

2. After opening the main screen, you can see the following function items:

- (1) Port Settings
- (2) Printer Information
- (3) Printer Configuration
- (4) Printer Function
- (5) Command Tool
- (6) Language
- (7) About
- (8) Exit

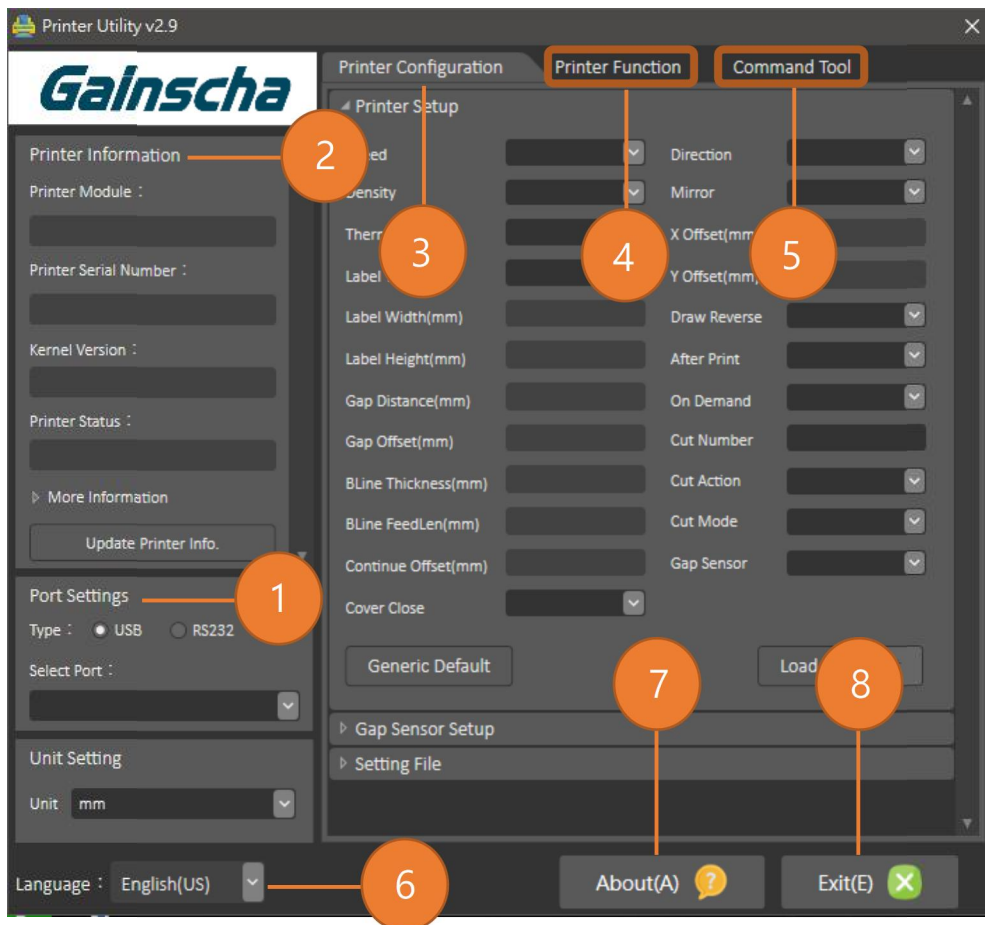

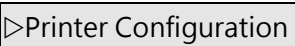
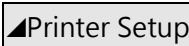

NOTE: If you need more detailed information, please refer to Gainscha official website <http://www.gainscha.com.tw/>

## 5.2 Printer Function

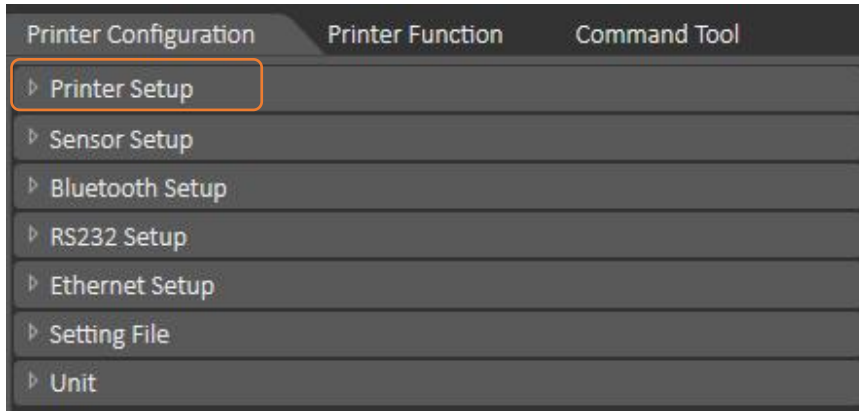
1. Click the  and  Can open and close the printer general settings screen.



2. Click the  Button to bring out all printer general setting information through the selected communication interface. Click the  button to write the setting value to the printer (please execute the reading function before writing).

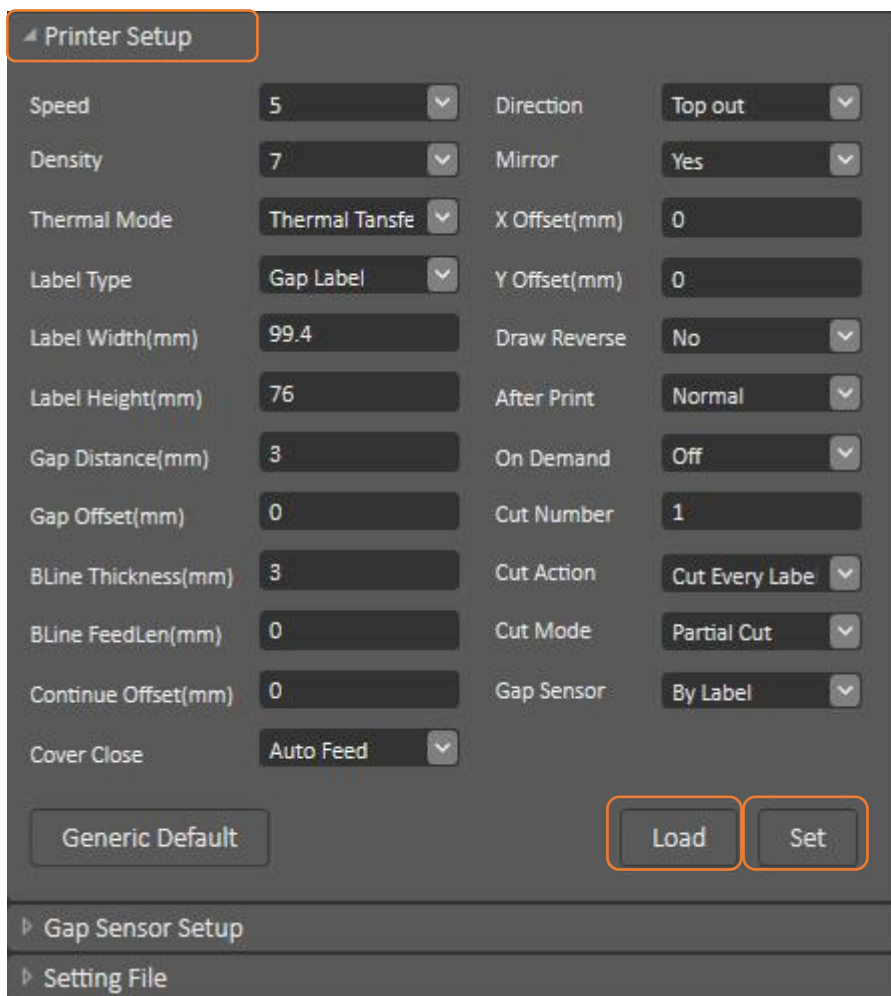

# 6. Communication Interfaces

---

## 1 ) USB (A Type)

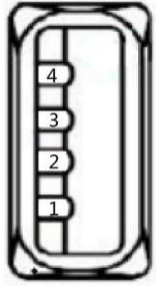

Pin No.	Pin Name
1	VBUS
2	D-
3	D+
4	GND

## 2 ) USB (B Type)

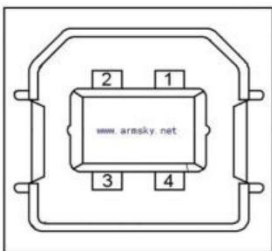

Pin No.	Pin Name
1	VBUS
2	D-
3	D+
4	GND



### 3 ) Serial Port

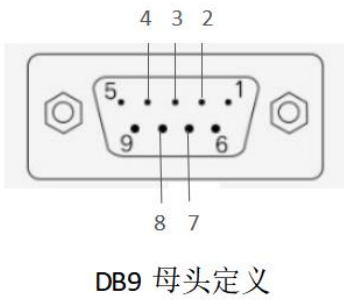

Pin No.	Pin Name	Description
1	-	-
2	TXD	Transmit Data
3	RXD	Receive Data
4	Connect to Pin6	Equipment to Judge
5	GND	System Ground
6	Connect to Pin4	Equipment to Judge
7	CTS	Clear to Send
8	RTS	Request to Send
9	-	Reserve (No output)

### 4 ) Ethernet Port

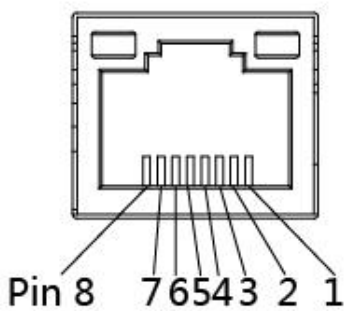

Pin No.	Pin Name
1	TX+
2	TX-
3	RX+
4	-
5	-
6	RX-
7	-
8	-

# 7. Troubleshooting

## 7.1 Common Problems

The following guide lists the most common problems that may be encountered when operating this bar code printer. If the printer still does not function after all suggested solutions have been invoked, please contact the Customer Service Department of your purchased reseller or distributor for assistance.

Problem	Possible Cause	Recovery Procedure
Power indicator does not illuminate.	<ul style="list-style-type: none"> <li>● The power cord is not properly connected.</li> </ul>	<ul style="list-style-type: none"> <li>● Plug the power cord in printer and outlet.</li> <li>● Switch the printer on.</li> </ul>
Out of ribbon	<ul style="list-style-type: none"> <li>● Out of ribbon.</li> <li>● The ribbon installation path is incorrect.</li> </ul>	<ul style="list-style-type: none"> <li>● Install new ribbon.</li> <li>● Follow the steps for installing the ribbon to reinstall.</li> </ul>
Out of paper	<ul style="list-style-type: none"> <li>● Out of paper.</li> <li>● The paper installation path is incorrect.</li> <li>● Gap / black mark sensor detection is incorrect.</li> </ul>	<ul style="list-style-type: none"> <li>● Install new paper.</li> <li>● Follow the steps for installing the paper to reinstall.</li> <li>● Recalibrate the label sensor.</li> </ul>
Paper jam	<ul style="list-style-type: none"> <li>● Gap / black mark sensor detection is incorrect.</li> <li>● The label size is set incorrectly.</li> <li>● Label may be blocked inside the printer.</li> </ul>	<ul style="list-style-type: none"> <li>● Recalibrate the label sensor.</li> <li>● Set the correct label size.</li> <li>● Cleaning the inside of the printer.</li> </ul>
Unable to print	<ul style="list-style-type: none"> <li>● Cable is not well connected to serial or USB interface or parallel port.</li> </ul>	<ul style="list-style-type: none"> <li>● Re-connect cable to interface.</li> <li>● Change a new cable.</li> <li>● Ribbon and media are not compatible.</li> <li>● Verify the ribbon-inked side.</li> <li>● Reload the ribbon again.</li> <li>● Clean the print head.</li> <li>● The print density setting is incorrect.</li> <li>● Print head's harness connector is not well connected with printhead. Turn off the printer and plug the connector again.</li> </ul>

Poor print quality	<ul style="list-style-type: none"> <li>● Ribbon and media is loaded incorrectly.</li> <li>● Dust or adhesive accumulation on the print head.</li> <li>● Print density is not set properly.</li> <li>● Printhead element is damaged.</li> <li>● Ribbon and media are incompatible.</li> </ul>	<ul style="list-style-type: none"> <li>● Reload the supply.</li> <li>● Clean the print head.</li> <li>● Clean the platen roller.</li> <li>● Adjust the print density and print speed.</li> <li>● Run printer self-test and check the print head test pattern if there is dot missing in the pattern.</li> <li>● Change proper ribbon or proper label media.</li> <li>● The print head mechanism does not latch the print head properly.</li> </ul>
Skip labels when printing	<ul style="list-style-type: none"> <li>● Label size is not specified properly.</li> <li>● Sensor sensitivity is not set properly.</li> <li>● The media sensor is covered with dust.</li> </ul>	<ul style="list-style-type: none"> <li>● Check if label size is setup correctly.</li> <li>● Calibrate the sensor by Auto Gap or Manual Gap options.</li> <li>● Clear the GAP/Black mark sensor by blower.</li> </ul>
The printing position of small label is incorrect	<ul style="list-style-type: none"> <li>● Media sensor sensitivity is not set properly.</li> <li>● Label size is incorrect.</li> <li>● The vertical offset setting in the driver is incorrect.</li> </ul>	<ul style="list-style-type: none"> <li>● Calibrate the sensor sensitivity again.</li> <li>● Set the correct label size and gap size.</li> <li>● If using the software BarTender, please set the vertical offset in the driver.</li> </ul>
Missing printing on the left or right side of label	<ul style="list-style-type: none"> <li>● Wrong label size setup.</li> </ul>	<ul style="list-style-type: none"> <li>● Set the correct label size.</li> </ul>
Wrinkle problem	<ul style="list-style-type: none"> <li>● Ribbon installation is incorrect.</li> <li>● Media installation is incorrect.</li> <li>● Print density is incorrect.</li> <li>● Media feeding is incorrect.</li> </ul>	<ul style="list-style-type: none"> <li>● Please set the suitable density to have good print quality.</li> <li>● Make sure the label guide touch the edge of the media guide.</li> </ul>
Gray line on the blank label	<ul style="list-style-type: none"> <li>● The print head is dirty.</li> <li>● The platen roller is dirty.</li> </ul>	<ul style="list-style-type: none"> <li>● Clean the print head.</li> <li>● Clean the platen roller</li> </ul>
Irregular printing	<ul style="list-style-type: none"> <li>● The printer is in Hex Dump mode.</li> </ul>	<ul style="list-style-type: none"> <li>● Turn off and on the printer to skip the dump mode.</li> </ul>

# 8. Maintenance

This session presents the clean tools and methods to maintain your printer.

1. Please use one of following material to clean the printer.
  - Cotton swab
  - Lint-free cloth
  - Vacuum / Blower brush
  - 100% ethanol

2. The cleaning process is described as following,

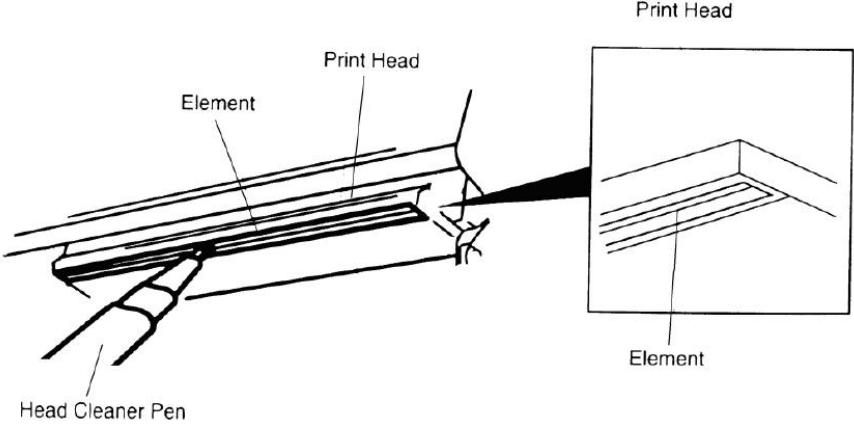
Printer Part	Method
Print Head	<ol style="list-style-type: none"> <li>1. Always turn off the printer before cleaning the print head.</li> <li>2. Allow the print head to cool for a minimum of one minute.</li> <li>3. Use a cotton swab and 100% ethanol to clean the print head surface.</li> </ol> 
Platen Roller	<ol style="list-style-type: none"> <li>1. Turn the power off.</li> <li>2. Rotate the platen roller and wipe it thoroughly with 100% ethanol and a cotton swab, or lint-free cloth.</li> </ol>
Tear Bar/Peel Bar	Use the lint-free cloth with 100% ethanol to wipe it.
Sensor	Compressed air or vacuum
Exterior	Wipe it with water-dampened cloth
Interior	Brush or vacuum

NOTE:

- Do not touch printer head by hand. If you touch it careless, please use ethanol to clean it.
- Please use 100% Ethenol.DO NOT use medical alcohol, which may damage the printer head.
- Regularly clean the print head and supply sensors once change a new ribbon to keep printer performance and extend printer life.
- The maximum printing ratio per dot line is 15% for this printer. To print the full web black line, the maximum black line height is limited to 40 dots, which is 5mm for 203 DPI resolution printer and 3.3mm for 300 DPI resolution printer.

## 9. Revise History

---

Date	Version	Content
2020/5/22	Ver.1.1	Add 3.6 Loading the Peeler note
2020/6/24	Ver.1.1.1	Modify 1.2.2 Printer Optional Features Add 3.4.3 External Label Roll Mount Installation (Option) note
2020/6/29	Ver.1.1.2	Modify chapter 4.1 LED Indicator
2020/8/13	Ver.1.1.3	Modify chapter 4.3 Power-on Utilities
2021/8/26	Ver.1.1.4	Add warning slogan
2022/3/16	Ver.1.1.5	Empower GS-2406TM Rename GS-2406T Empower GS-3405TM Rename GS-3405T
2022/4/28	Ver.1.1.6	Modify chapter 6 add communication interfaces